



# SUCHE

Monocomando para lavatorio para apoyar.

Código Z106/S9.0



## Plano

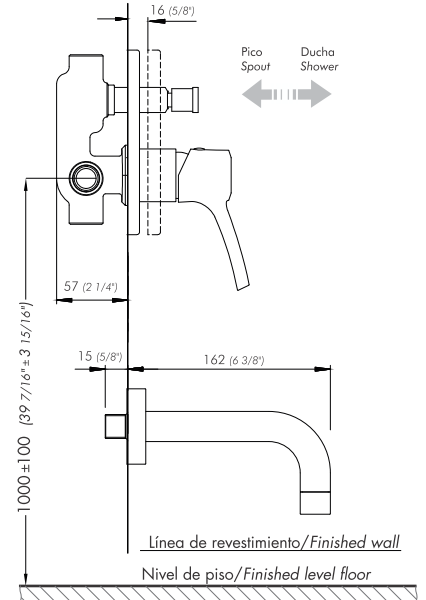
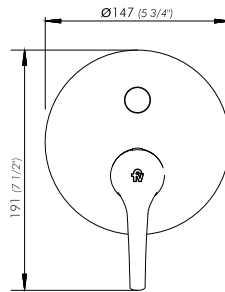

\*dimensiones en milímetros

\*dimensiones en pulgadas

## Acabados



## Detalle técnico

Instalación	Sobre pared
Material	Metal cromado
Presión de operación	0.4 a 4 bar
Peso	1,361 kg
Volumen	3.655 cm <sup>3</sup>

## Incluye

Juego armado
Chapa vista
Manija con prisionero
Pico con roseta
Folleto de instalación

## Características



## Gráfico de cálculos de operación

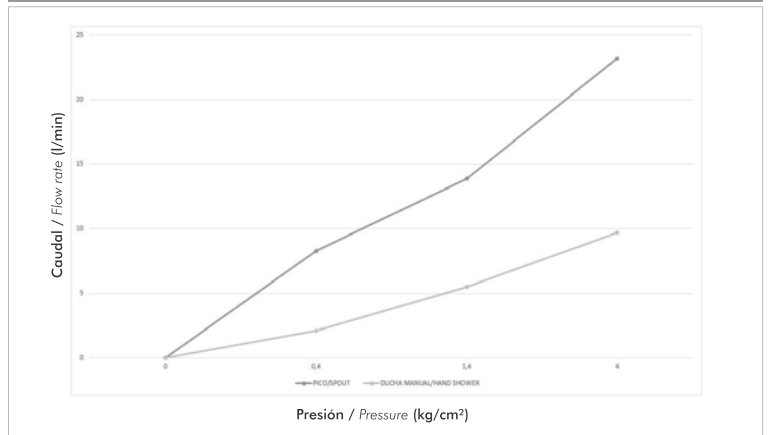

La medición de caudal fue realizada con la salida del cuerpo libre de restricciones.

## Nosotros



Bernardo de Irigoyen 1053 - B1604AFC  
Florida - Pcia. de Buenos Aires - Argentina  
Tel.: +54 (011) 4730-5300

## Contacto

Web: [www.grupofv.com](http://www.grupofv.com)  
E-mail: [contacto@grupofv.com](mailto:contacto@grupofv.com)  
Facebook: [Grupofvoficial](#) Instagram: [grupofvoficial](#)

UTILIZA SIEMPRE REPUESTOS ORIGINALES FV





# SUCHE

Single handle bath/shower set, shower not included.

Code Z106/S9.0



### Diagram

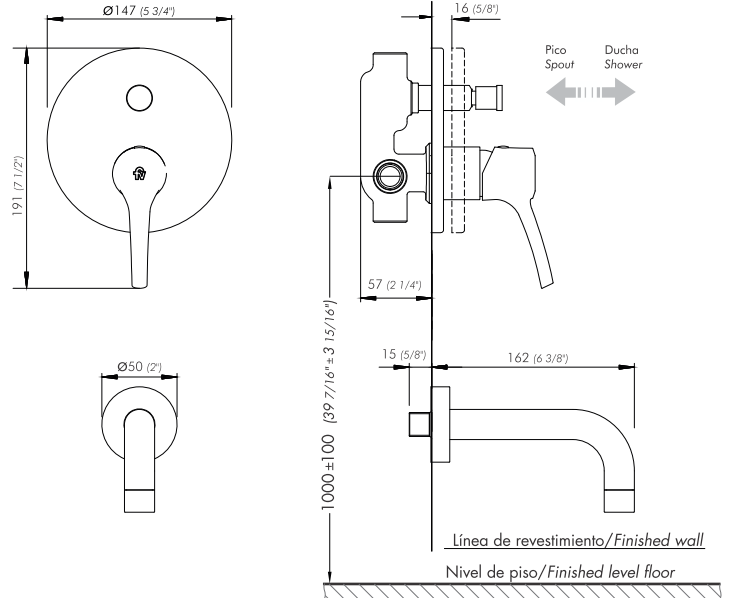

\*dimensions in millimeters

\*dimensions in inches

### Finishes



### Product detail

Instalation	Wall mounted
Material	Chrome metal
Pressure	0.4 a 4 bar
Item weight	1,361 kg
Volume	3.655 cm <sup>3</sup>

### Included

Armed set
Cover view
Handle
Rosette with spout
Instalation brochure

### Flow rate chart

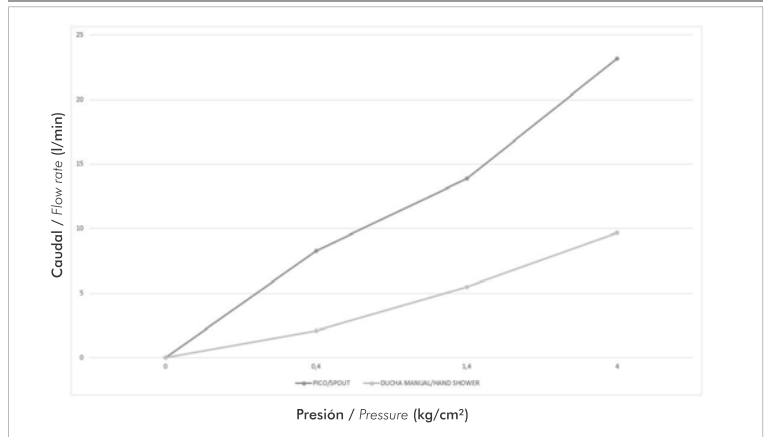

Flow measurement was performed with body water outlet free of restrictions.

### Features

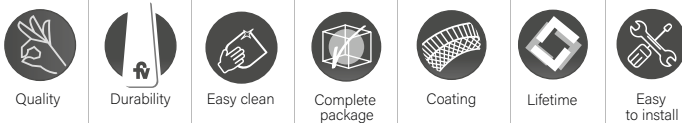

### About us



Bernardo de Irigoyen 1053 - B1604AFC  
Florida - Pcia. de Buenos Aires - Argentina  
Tel.: +54 (011) 4730-5300

### Contact

Web: [www.grupofv.com](http://www.grupofv.com)  
E-mail: [contacto@grupofv.com](mailto:contacto@grupofv.com)  
Facebook: [Grupofvoficial](https://www.facebook.com/grupofvoficial) Instagram: [grupofvoficial](https://www.instagram.com/grupofvoficial)

ALLWAYS USE  
ORIGINAL  
FV SPARE  
PARTS





# SUCHE

Monocomando para banheira e chuveiro, chuveiro não incluído.

Código Z106/S9.0



## Plano

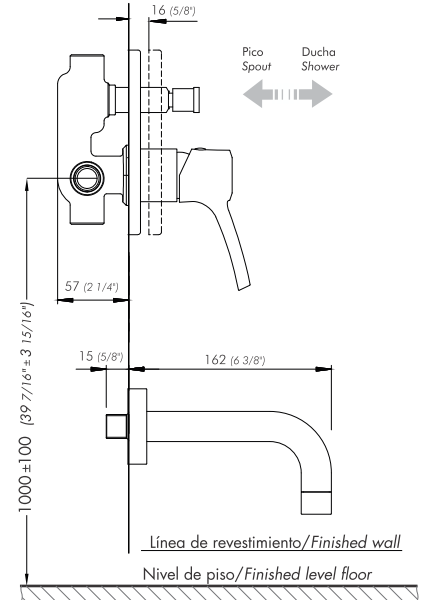
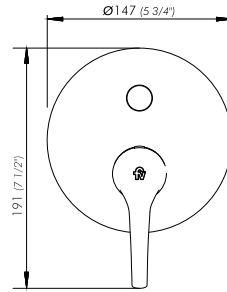

\*dimensões em milímetros e polegadas

## Acabamentos



## Informações técnicas

Instalação	Wall mounted
Material	Chrome metal
Pressão de uso	0.4 a 4 bar
Peso	1,361 kg
Volume	3.655 cm <sup>3</sup>

## Incluído

Conjunto armado
Tampa
Volante completo
Bico com roseta
Folheto

## Características



## Gráfico de cálculo de operação

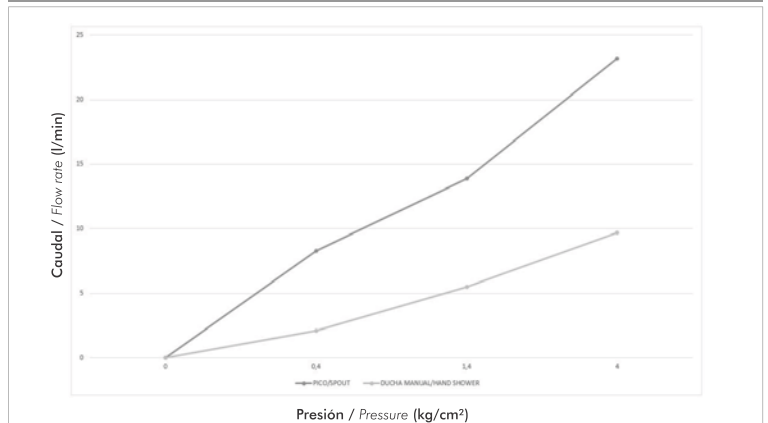

A medição do fluxo foi realizada com a saída do corpo livre de restrições.

## Sobre nós



Bernardo de Irigoyen 1053 - B1604AFC  
Florida - Pcia. de Buenos Aires - Argentina  
Tel.: +54 (011) 4730-5300

## Contato

Web: [www.grupofv.com](http://www.grupofv.com)  
E-mail: [contacto@grupofv.com](mailto:contacto@grupofv.com)  
Facebook: [Grupofvoficial](#) Instagram: [grupofvoficial](#)

UTILIZE SEMPRE  
PEÇAS DE  
REPOSIÇÃO  
ORIGINAIS

